



Sonar Guide

USER INSTRUCTIONS

The **Sonar Guide** alerts the user to drop-offs, step-ups, and low-level obstacles in their path of travel



Rollator Dolomite Walker

INSTALLING

1 COMPONENTS

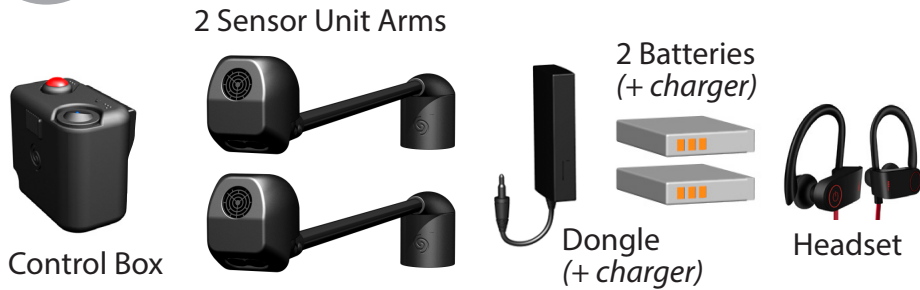

The headset is already paired but you can use your own headset (follow manufacturer's instructions). To pair the headset to the dongle if needed press and hold dongle power button until dongle light flashes **blue** and **red** (6 seconds). Release the power button. Place your headset within 3 feet of the dongle and press and hold its power button until light flashes **blue** and **red** for 3 seconds. Release headset power button and wait for devices to pair (~1 min.)

CAUTION: The system must be used only according to directions and procedures described here. Avoid looking straight into the lower sensor when the power is turned on. Turn it off when not in use. Do not leave within the reach of children.

2 INSTALLING SENSOR ARMS

1. Install Sensor Arms

Snap sensor arms onto front frame. Insert and tighten the clamp screw.

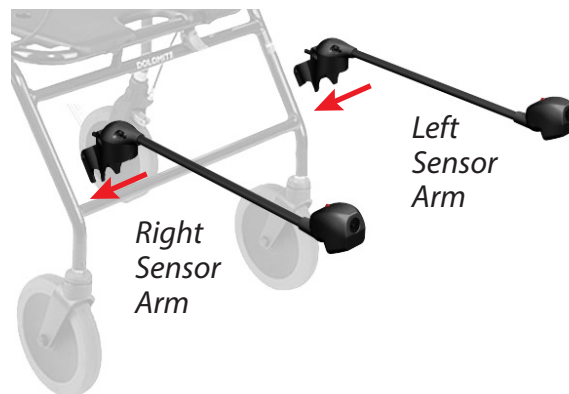
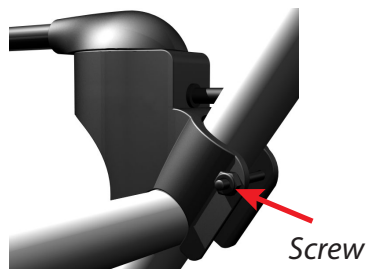

3 INSTALLING CONTROL BOX

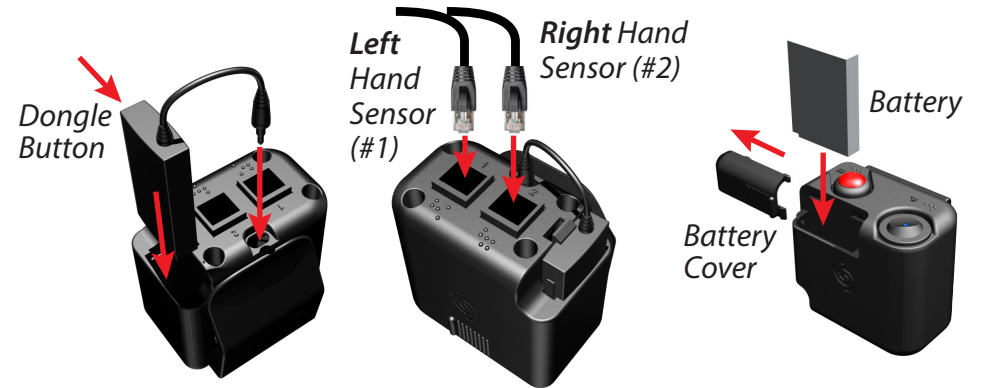

1. Install Dongle

Insert dongle and plug it in as shown.

2. Connect Sensors

Insert plugs into jacks #1 & #2.

3. Install Battery

Insert battery with contacts on the right.

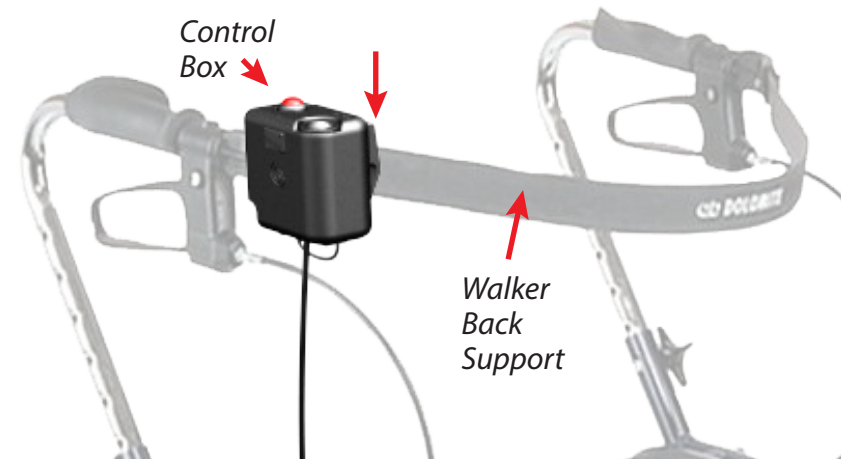

4. Install Control Box

Slide the Control Box's clip over the walker's back support. Adjust cable routing to avoid interference with moving parts. Attach cables to wheelchair with ties (included)

OPERATING

1 CALIBRATING

1. Position Sonar Guide over a **hard, flat surface**. (Make sure there are no obstacles between the Sonar Guide and the floor.)

2. Position each arm, and turn **Power Switch ON**. (Units calibrate one after another.)

A single beep and a **blinking green** LED indicates the beginning of calibration. When completed, you will hear **three beeps**, and the LED will go **off**, indicating the Sonar Guide is ready for use.

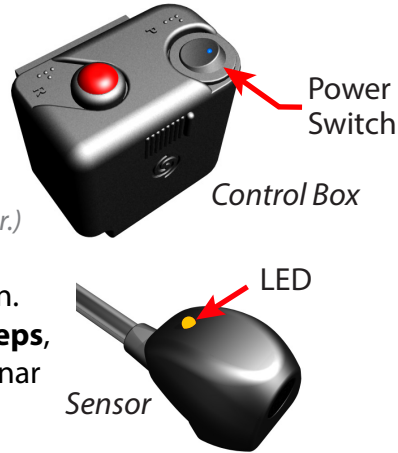

2 OPERATING

1. **Position Sonar Guide Arms**

Position Sonar Guide arms by extending them away towards potential obstacles.

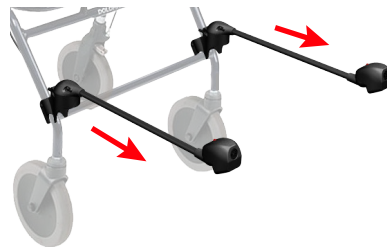

2. **Detecting Step-Ups and Dropdowns**

When drop-off or step-up is detected, the LED will turn **yellow** and you will hear a voice in the headset say one of the following: "Dropdown Right", "Dropdown Left", "Step-Up Right", "Step-Up Left", or either just "Dropdown", or just "Step-Up" if both units detect at the same time (even if an obstacle is also detected at the same time, only the step-up is announced).

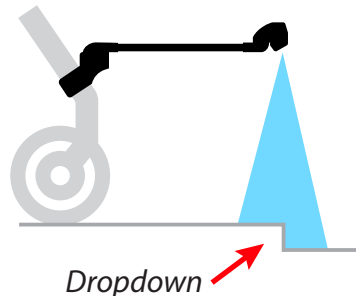

3. **Detecting Obstacles**

When an obstacle is detected, the LED will turn **red** and you will hear a voice in the headset say "Obstacle Right", "Obstacle Left", or just "Obstacle" (no elevation changes).

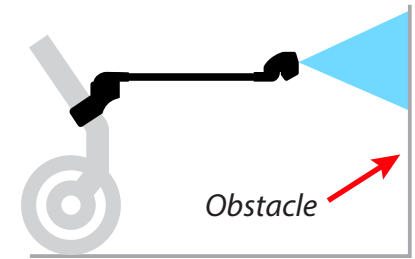

Sonar Guide detects obstacles in the user's path of travel below waist level at 3 different distance settings, customizable at request. The peripheral obstacles outside of the sensor's range will not be detected.

Sonar Guide will detect changes in elevation (drop-offs and step-ups) of 3 or more inches.

3 ADJUSTMENTS

1. **Range Adjustment**

To change the obstacle detection range press the **Range Button** repeatedly until desired distance is announced (custom settings at request).

2. **Turning Headphones ON & OFF**



To turn headphones off press & hold dongle button for 3 sec, then press & hold headset button for 3 sec until "Power off" is heard.

3. **Turning Dongle ON & OFF**

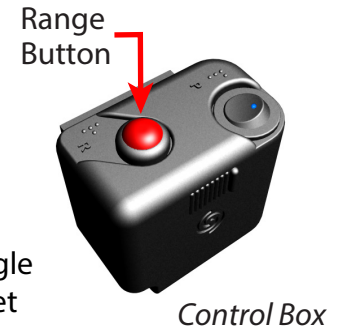
Dongle stays paired as long as it is ON. To turn it either OFF, or ON press and hold **dongle button** for 3 sec.



LED Alerts Guide

- Blinking GREEN:  **Calibrating**
- Solid RED:  **Obstacle** detected
- Solid YELLOW:  **Elevation** change detected

Beep Tone Guide

- (1) **Single beep:**
Power is **ON** and Sonar Guide is **calibrating**
- (3) **Three beeps:**
Calibrating completed

MAINTENANCE

1 MAINTENANCE

Sonar Guide does not require scheduled maintenance. **DO NOT USE WATER OR CLEANING SOLUTION TO CLEAN THE UNIT, THE LIDAR OR THE SONAR SENSOR.** Clean the unit housings by wiping them with a damp cloth. Clean the sonar sensor with a microfiber cloth or paper towel.

2 TROUBLESHOOTING

If the the Sonar Guide does not power on, insert a fully charged battery and make sure the sonar sensors are not blocked. Then turn the power ON and wait for the beep tone. Turning the power off and on again will reset the sensors. For technical support or customer service contact G-Technology Group.

3 WARRANTY

Sonar Glasses have an unconditional 1-year warranty and satisfaction guarantee. The warranty covers defects in manufacturing and workmanship. An extended warranty and protection plan are also available. Sonar Guides are made in the USA.

4 CONTENT

The Sonar Guide kit contains: 2 Sensor Arms, 1 Control Box, 2 rechargeable lithium-ion batteries, 1 battery charger, 1 dongle, and 1 headset.

5 SAFETY GUIDELINES

SONAR GUIDE IS ONLY INTENDED AS AN ASSISTIVE ALERT DEVICE AND ITS ACCURACY MIGHT BE LIMITED BY THE COMPLEXITY OF ENVIRONMENTAL CONDITIONS. NOT INTENDED FOR USE IN THE RAIN. DO NOT ALLOW THE SENSORS TO GET WET. DO NOT USE IN TEMPERATURES EXCEEDING 130°F OR 55°C. DO NOT ATTEMPT TO DISASSEMBLE. THE SYSTEM MUST BE USED ONLY ACCORDING TO DIRECTIONS AND PROCEDURES DESCRIBED. AVOID LOOKING STRAIGHT INTO THE LOWER SENSOR WHEN THE POWER IS TURNED ON. TURN IT OFF WHEN NOT IN USE. DO NOT LEAVE WITHIN THE REACH OF CHILDREN.



G-TECHNOLOGY GROUP™

For more info contact:

G-Technology Group
571-249-1290, ex 1120
info@sonarglasses.com

